

The Axis AX Series Configured Command Centers from Advanced have been designed to support a wide variety of applications. The command centers are fully compatible with the Axis AX Series Intelligent Fire Alarm Control Panels and the Axis AX “V” Series Intelligent Fire Alarm Control Panels with Integrated Audio.

Axis AX Series Configured Command Centers come in 3 variations: AX-CC1-16 (Single Loop), AX-CC2-16 (Two Loops) and AX-CC4-16 (Four Loops). Each command center comes in a 22.6”H x 20.3”W x 5.5”D cabinet and includes: one AX-DSP, keyboard display, one main base card (configured for 1,2 or 4 SLC loops), one AX-ACB, AC input board, an AV-AMP-80, audio amplifier (two 40 Watt speaker outputs), one AX-PSU-6, amplifier power supply and one AX-ASW-16, switch LED module.

The command center cabinet has been designed to support a wide range of additional option modules to suit specific application requirements. The option modules provide the following capabilities: DACT, city tie, networking, modem, I/O drivers, switch and relay modules, as well as many others. Consult with the factory for more details on the Axis AX Series module range.

In order to simplify installation, programming, troubleshooting, training and support, all of the Axis AX Series fire panels & command centers can be programmed using the same Windows based programming tools. In addition, a “family” consisting of all of the Axis AX Series main PCBs, option modules, peripherals and intelligent devices are fully compatible across the full range of Axis AX Series fire panel & command center products.

In order to simplify control and operation of a large, networked, wide area or high rise system, each command center will support up to 252 individually assignable switches through use of up to sixteen AX-ASW-16, Switch LED Modules. These modules mount to the inner doors of the command centers. The switch action may be either toggle, on/off or push button. Each switch is associated with 3 LEDs that are red, yellow and green. These LEDs are each fully programmable and can be set to turn on steady and/or to blink. A large area is made available per switch and LED for user defined text that may clearly identify the intended function. With such versatility, operation and control is simplified, status is readily available and quickly identified.

Examples of switch operations include: Fan and HVAC control, paging area select, message select, telephone control, purging, zone/area/point bypass, etc. The total number of switches supported across a maximum configured network is 51,200. A key feature is that individual switch and LED response time is not affected by the size of the network and each switch and LED can be assigned to network functions as well as individual panel functions.



Features

- 1, 2 and 4 SLC Loop Options
- Integral 80 Watt Amplifier
- Built-in Paging Microphone
- Configured with One AX-ASW-16 Switch LED Module
- Networkable – up to 200 Intelligent Panels
- Integrated 80 Watt Digital Audio Features include:
 - 2 Class A or B, 40 Watt, 25 Vrms Outputs
 - Programmable 16 Channel Message Generator
 - Automatic one-to-one Backup Capability
- Local internally mounted Microphone and Switches provide:
 - All call, Alert and Selective Messaging and Paging by Zone or Area
- Up to 504 Analog Addressable Points
- Multiple Command Centers w/Control Options
- Mass Notification Programming Options
- Synchronized Audio and Visual Control (Panel or Network Wide)
- AV-VB Boosters expand Audio Wattage (16 per panel)

Listings and Approvals

- ETL ANSI/UL 864/1711/1481 Listed: 101564744NYM-001, 100027836NYM-001c
- CSFM Approved: 7165-1713:0101
- NYC FD COA #6105A2

Supplied with a single AV-AMP-80, Amplifier Module, with associated AX-PSU-6, Power Supply Charger, and AV-MIC, Microphone Module, each command center can expand audio wattage with the addition of Advanced AV-VB, Audio Boosters. Each AV-AMP-80 and AV-VB's have two 40 Watt speaker circuits (may be programmed as 1:1 backup). Through either manual or automatic controls, live or recorded audio messages can be sent to any location in a facility.

Control functions can include: All Call, All Evac, All Alert, Message Select and Area Select. For instant control of paging to all areas, press the All Call button. To generate and play an evacuation message or an alert message throughout a facility press the All Evac or All Alert button. To play a specific message (up to 16 messages) in specific areas, use the individual message selection buttons followed by the individual area selection buttons.

A typical high rise application may be configured with an AV-VB, Audio Booster, per floor. The boosters are controlled by the Control-by-Event logic at the command center to generate specific messages upon specific conditions. It is easy to program for example a typical fire floor, floor above, floor below evacuate message simultaneous with adjacent alert floor messages, while simultaneously providing the capability to override automatic messages at any time with manual paging to all or selective areas.

Simplifying and reducing initial system set-up, Axis AX Series Configured Command Centers are equipped with an installer-friendly "Auto-Learn/Loop Detection" feature that permits the rapid recognition of all signaling line circuits' devices. This rapid recognition, simplifies the assignment of critical life safety functions immediately. Assignments include: intelligent detector type and operation criteria, addressable input device recognition as an alarm input, and addressable output control on a general alarm basis.

Designed with built-in powerful installation and customization tools, the Axis AX Series Configured Command Centers can adapt to virtually any application requirement.

With DynamiX programming, typical time consuming complexities associated with I/O relationship programming such as two-stage, multi-pattern NAC control, intelligent detector drift compensation, precision response/sensitivity mode settings, flexible timing functions, and more, are sharply reduced.

The Axis AX Series Configured Command Centers are fully field programmable via the onboard graphical LCD display and alphanumeric keypad (AX-DSP). Front panel programming may encompass defining input to output relationships, configuring output circuit characteristics, entering zone, device, and other text descriptions, and configuring multiple user-access passwords.

To maximize the capability and flexibility of the Axis AX Series Configured Command Centers, and expand upon the customization of an installation, the Advanced Windows based PC-NeT field configuration tool is available. The PC-NeT field configuration tool is a powerful, user-friendly programming tool that allows users to perform virtually any I/O relationship with multiple criteria. Simple drop-down menus with point-and-click operation makes project commissioning and troubleshooting fast and efficient.

Designed with the technician in mind, each module of the Axis AX Series Configured Command Center is easy to install and service. The integral power supply offers status LEDs, temperature compensated charging, and the ability to operate directly from the batteries when AC supply is not yet available at the installation site. A unique built-in intelligent multi-meter allows technicians to interrogate any input and/or output and diagnose potential time consuming trouble issues with virtually no complications or aggravation. With an Axis AX Series Configured Command Center, servicing a customer after installation can be as simple as using the Advanced Remote Diagnostic Virtual Panel Simulator and/or ipGateway (AX-LAN). The ipGateway (AX-LAN) provides real time text and email alerts of system status.

Graphical Liquid Crystal Display Navigation Buttons

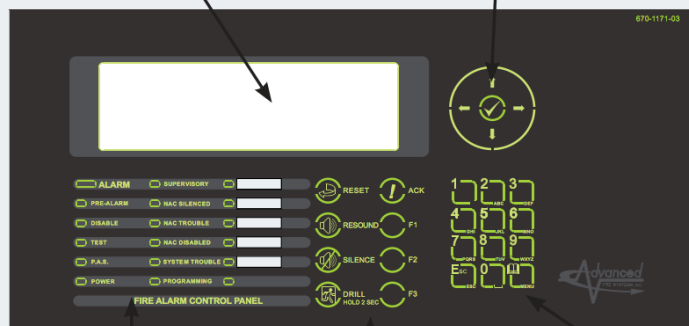









LED Status Indicators Control Buttons 12 Button Keypad (Numbers & Letters)

Advanced User Interface w/Graphical LCD:

Designed to be user-friendly and easy to operate, the Advanced User Interface w/Graphical LCD (backlit 240 x 64) is the information and control center for the Axis^{AX} Series Intelligent Fire Alarm Control Panel(s).

The unit incorporates a graphical LCD display, LED status indicators, control buttons (including 3 programmable buttons), navigation buttons, and a 12 button keypad for complete system status, interrogation, and control.

| Button (Keys) | |
|--|---|
|  | Reset |
|  | Ack (panel buzzer acknowledge) |
|  | Resound (resound signals) |
|  | Silence (silence signals) |
|  | Fire Drill |
|  | Function Keys (3 - programmable control buttons) |
|  | Navigation Keys (up, down, left, right, and tick [enter]) |
|  | 12 Button Keypad (numbers, letters, esc, and menu) |

| LED Indicators | |
|-----------------------|--------|
| Alarm | Red |
| Pre-Alarm | Red |
| Disable | Yellow |
| Test | Yellow |
| P.A.S. | Yellow |
| Power | Green |
| Supervisory | Yellow |
| NAC Silenced | Yellow |
| NAC Trouble | Yellow |
| NAC Disabled | Yellow |
| System Trouble | Yellow |
| Programming | Yellow |
| Programmable LED 1 | Red |
| Programmable LEDs 2-5 | Yellow |

Wiring Diagram

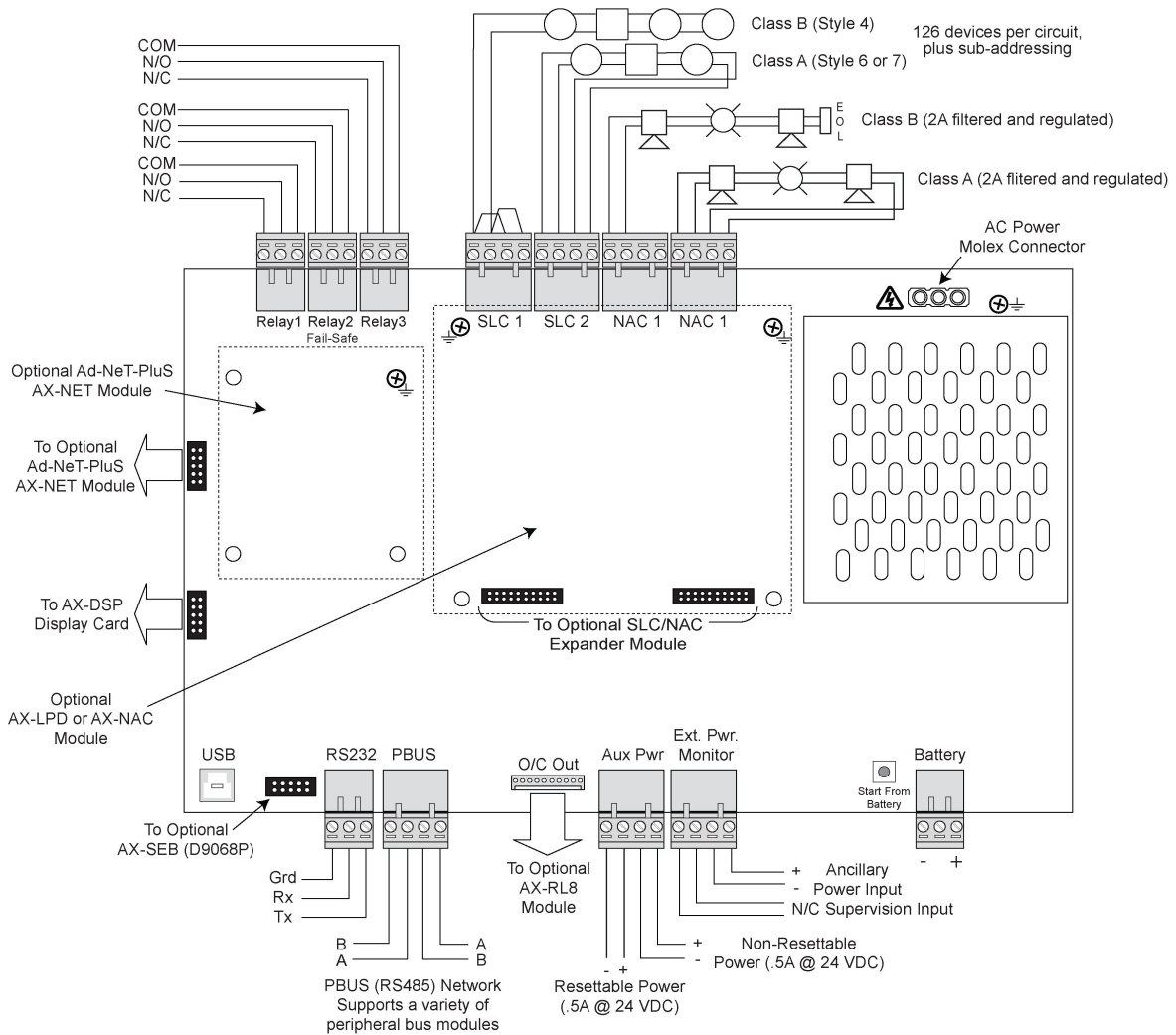

Specification

| | | |
|--------------------------------------|--|--------|
| Operating Voltage | 120 VAC (1.4A) - 240 VAC (0.7A), 50/60Hz | |
| System-Brown-Out | 98 VAC nominal | |
| Battery Circuit | | |
| Charging Voltage | 27.4 VDC nominal | |
| Temp. Compensated | | |
| Charging Current | 2 Amp | |
| Battery Derating Factor | 0.83A | |
| Battery Capacity | 7 Ah (minimum), 48 Ah (maximum) | |
| Battery Fuse | 5A @ 240 VAC, Time Delayed, Ceramic, High Breaking (In-line Wire Link) | |
| Fire Supervisory, and Trouble Relays | (Power Limited - When utilizing system power) | |
| Type | Form "C" | |
| Rating | 1A @ 30 VDC/VAC | |
| Trouble Relay | Normally Active (fail-safe operation) | |
| Auxiliary Power Outputs | (Power Limited) | |
| Resettable | | |
| Voltage | 24 VDC | |
| Current | 0.5A | |
| Reset Time | 10-15 Seconds | |
| Non-Resettable | | |
| Voltage | 24 VDC | |
| Current | 0.5A | |
| Humidity | 85% RH | |
| Temperatures | Operating: 32 °F - 120 °F (0 °C - 49 °C) Recommended Room: 60 °F - 86 °F (15 °C - 27 °C) | |
| Enclosure Dimensions | | |
| Back Box | 22.6"H X 20.3"W X 5.5"D | |
| Housing | 24.1"H X 21.5"W X 6.3"D | |
| SLC Loop | (Power Limited) | |
| Class (Style) | Class A or B (Style 4, 6 or 7) | |
| Voltage | 24 VDC | |
| Minimum Return Voltage | 17 VDC | |
| Current | 0.5A | |
| NAC Circuits | (Power Limited) | |
| Class (Style) | Class A or B | |
| Voltage | 24 VDC (filtered and regulated) | |
| Minimum Return Voltage | 16 VDC | |
| Current | 2A (each) | |
| Maximum Voltage Drop | 3 VDC | |
| Maximum Line Impedance | 1.5Ω | |
| RS232 | Supervised, Optically Isolated | |
| Baud Rate | 9600 | |
| Parity | None | |
| Data Bits | 8 | |
| Stop Bits | 1 | |
| Base Card Operating Current | Quiescent | Alarm |
| AX-CTL-1PCB | 110 mA | 195 mA |
| AX-CTL-2PCB | 110 mA | 195 mA |
| AX-CTL-4PCB | 175 mA | 260 mA |
| AV-AMP-80 | | |
| Input Voltage (DC) | 24 VDC (operating range 15-30 VDC) | |
| Amplifier #1 Output | 40 Watts @ 25 Vrms, Class A or B Wiring | |
| Amplifier #2 Output | 40 Watts @ 25 Vrms, Class A or B Wiring | |
| Activation | RS-485 (PBus) or Contact Closure | |
| AV-MIC | Supervised Microphone Input | |

*Refer to Axis AX Series module data sheets for optional modules specifications.

Order Codes and Options

| | |
|---------------|--|
| AX-CC1-16* | Axis AX Series Command Center with cabinet, 2 power supply's/chargers, 1 SLC, 2 NACs, two 40 watt speaker circuits, 1 AXASW-16 switch LED module and microphone (126 addressable points) |
| AX-CC2-16* | Axis AX Series Command Center with cabinet, 2 power supply's/chargers, 2 SLC, 2 NACs, two 40 watt speaker circuits, 1 AXASW-16 switch LED module and microphone (252 addressable points) |
| AX-CC4-16* | Axis AX Series Command Center with cabinet, 2 power Supply's/Chargers, 4 SLC, 4 NACs, two 40 watt speaker circuits, 1 AXASW-16 switch LED module and microphone (504 addressable points) |
| | AX-CTL base card option modules**: |
| AX-LPD | 2 SLC, 2 NAC expander card |
| AX-NAC | 2 NAC expander card |
| AX-PSU | 5 Amp expansion power supply module |
| AX-NET4 | Network interface card (Style 4) |
| AX-NET7 | Network interface card (Style 7) |
| AX-012 | Thermal strip printer |
| AX-SEB/D9068P | Serial expansion board and serial digital alarm communicator |
| | AV-AMP-80 amplifier option module: |
| AV-ZS | Audio zone splitter module |
| AV-V70 | Universal audio converter (Converts 25 Vrms to 70 Vrms) |

* For gray enclosure, suffix "G" to part number. ** Refer to Axis AX data sheets for peer to peer network and peripheral bus modules.

[Check if this document is up to date](#) | [Give us feedback](#)

Advanced, 100 South Street, Hopkinton, MA. 01748 T: +508 435 9995 E: usa@advancedco.com W: us.advancedco.com

As our policy is one of constant product improvement the right is therefore reserved to modify product specifications without prior notice.